

# A ladar design and implement with a small size and real-time imaging

KEJIA YI<sup>a,b,\*</sup>, TIANXU ZHANG<sup>b</sup>, QINGHUA MENG<sup>c,d</sup>, TINGQUAN DENG<sup>a</sup>

<sup>a</sup>College of Computer Science and Technology, Harbin Engineering University, Harbin 150001, China

<sup>b</sup>Laboratory for Multispectral Information Processing Technologies, Institute for Pattern Recognition and Artificial Intelligence, Huazhong University of Science and Technology, Wuhan 430074, China

<sup>c</sup>National Laboratory for Optoelectronics, 1037 Loyu Road, Wuhan 430074, China

<sup>d</sup>College of Physics and Electronic Engineering, Guangxi Teachers Education University, Nanning, Guangxi 530023, China

A new ladar design and implement with a small size and real-time imaging using a MEMS microscanning mirror are described in this paper. The new ladar system consists of laser diode, collimating lens, beam splitter, MEMS microscanner, bandpass filter, photodetector and signal processing devices. The system structure and its parameters are discussed in detail. A range resolution of about 1 cm, FOV of 30° and resonant frequency of 1.5 KHz can be achieved. This next generation of three dimensional MEMS ladar system will be high accurate, low price, small size and real-time imaging.

(Received July 30, 2010; accepted August 12, 2010)

*Keywords:* MEMS ladar, Microscanning mirror, Real time imaging, MEMS scanner

## 1. Introduction

Fig. 1 shows a conventional flash ladar (single-shot ladar) system. It is large in size (more than 15,000 cm<sup>3</sup>), heavy (more than 15kg), slow in speed (less than 1fps) and expensive in price (more than \$100,000). Fig. 2 presents a MEMS single point scanning ladar with small size (less than 500 cm<sup>3</sup>), light weight (about 1 kg), cheap (about \$10,000) and operation in real-time imaging (15 fps).

There are some problems to make flash ladar system impractical for most uses [1-3]. Due to the fact that number of photons reflected from a flash ladar will be much smaller than that from a MEMS single-point ladar. To yield an identical energy at a target area, pulse energy from the flash laser system for a 320×240 pixel imaging system would have to be at least 76,800 times more powerful than that from the MEMS laser ladar system, if all other characteristics are the same. The reason is that the flash laser must illuminate the entire target area shown in Fig. 1 a, rather than just 1/76800 of the target area as the MEMS ladar shown in Fig. 2 a. Furthermore, the reflected pulse energy from the flash single pulse ladar then needs to be distributed across the entire 320×240 FPA detectors, resulting in an additional 76,800 times decrease in the number of photons per detector. It means that pulse energy of the flash laser ladar system would need to be at least 10<sup>9</sup> times more powerful than that of the MEMS laser ladar system.

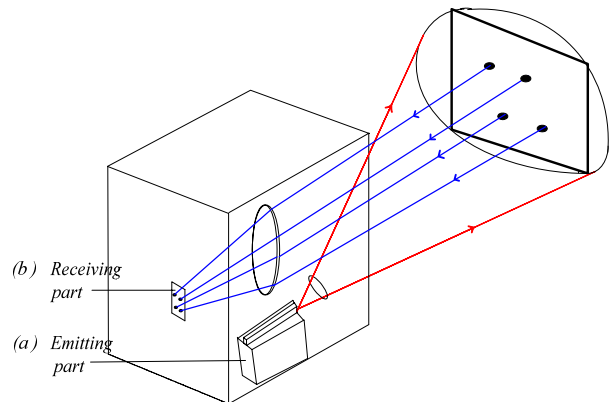

Fig. 1. Conventional flash single pulse ladar.

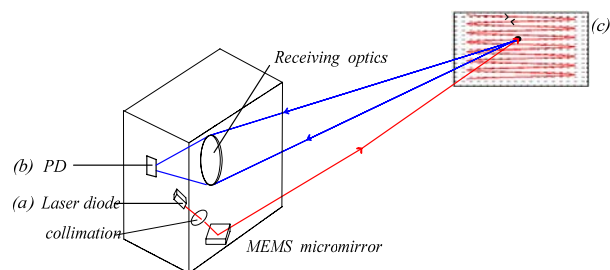

Fig. 2. MEMS single-point microscanning laser: a) emitting laser beam; b) receiving reflected signal from the target; c) single-point scanning module.

## 2. MEMS lidar system

MEMS lidar system can be implemented with a small size, real time imaging and range resolution of less than 1 cm [1-4]. We design a MEMS microscanning lidar prototype and the schematic setup is shown in Fig. 3. The modulated laser beam is directed onto a target region (e.g. an airplane) via a collimating lens, beam splitter and 2-axis scanning MEMS mirror, and is then reflected from the target surface. The reflected light from the target reaches a photodetector via the identical 2-axis scanning MEMS mirror, the beam splitter, the bandpass filter and the focusing lens. The laser diode is used with hundreds of milliwatts and wavelength of 1550 nm. The 2-axis scanning MEMS mirror is the key component which will be discussed in detail in the next paragraph. The photodetector consisting of indium gallium arsenide with a gigahertz-speed and a high responsivity at wavelength of 1550nm is used as a signal receiver. The output signal from the photodetector is then amplified and processed. The system design parameters are as follows: the range resolution which is the smallest radial distance between two recognizable targets is about 1cm, the field of view is 30°, and the resonant frequency is 1.5 KHz.

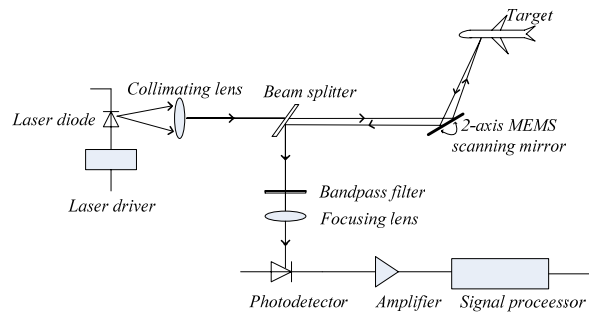
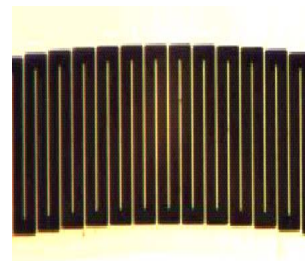
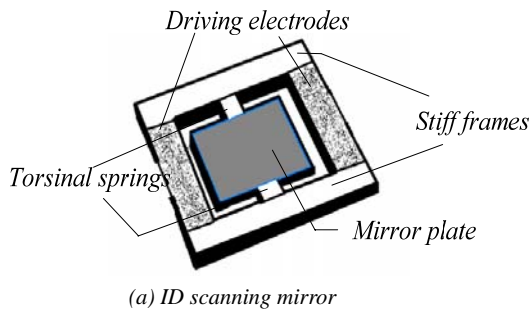

Fig. 3. 3D real time lidar based on scanning MEMS mirror.

## 3. Mems Microscanning mirror

There are several kinds of MEMS microscanning mirrors using different driving principles such as electrostatic actuation [4-6], electromagnetic force [7], piezoelectric effect et al. [8]. We choose the module of the electrostatic driving MEMS scanner because it is more compatible with a CMOS technology.

A deflectable mirror plate with lateral out-of-plane comb driving is used, and the 1D MEMS scanner structure including the mirror plate, torsional springs and driving electrodes is shown in Fig. 4. Fig. 4b shows an amplified comb electrode with 10\*100 μm fingers and 10 μm gaps.



(b) Amplified comb driving electrode

Fig. 4. Electrostatic driving 1D structure with out-of-plane comb actuation.

The narrow electrode gap of 10 μm between two neighbouring comb fingers produces a large capacity variation and consequently a large torsion while the microscanner works. The driven mirror enables a deflection angle of 15° at low driving voltage of 25 V in a resonant operation mode. The electrostatic microscanner is fabricated by a single crystalline silicon using MEMS process compatible with CMOS technology. The movable mirror plate is suspended in the stiff frames by two torsional springs as shown in Figs. 4 and 5. The design and fabrication are discussed by H. Schenk et al in detail [3-6].

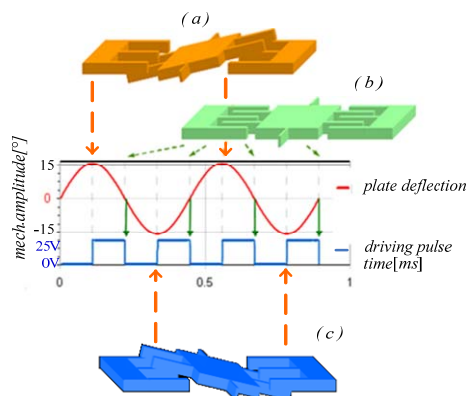

Fig. 5. The positions of movable mirror Vs voltage pulses.

The operation principal is described as follows. While a voltage pulse between the driving electrode and the deflected mirror plate turns on, the produced electrostatic force accelerates the plate toward rest position shown in Fig. 5 a. When the voltage pulse turns off, the mirror plate passes a rest position shown in Fig. 5 b, and then the plate swings through the rest position by inertia. The inertia movement is only controlled by mechanical properties such as spring stiffness, the moment of inertia of the plate, viscous damps of the micromirror etc. The next voltage pulse starts at the maximum deflection angle (Fig. 5 c) and ends again at the rest position (Fig. 5 b). The mirror can be

only operated resonantly with the driving pulse. The driving pulse is twice the mechanical resonance frequency. Phase relationship between the movable mirror position and the driving pulse shown in Fig. 5 a, b and c indicates that timing of the drive pulses and the deflection angle is synchronized therefore a stable operation point and a fixed deflection amplitude are guaranteed.

Fig. 6 shows a two dimensional microscanning mirror with comb driving electrodes. The operation principal is the same as the 1D microscanning mirror.

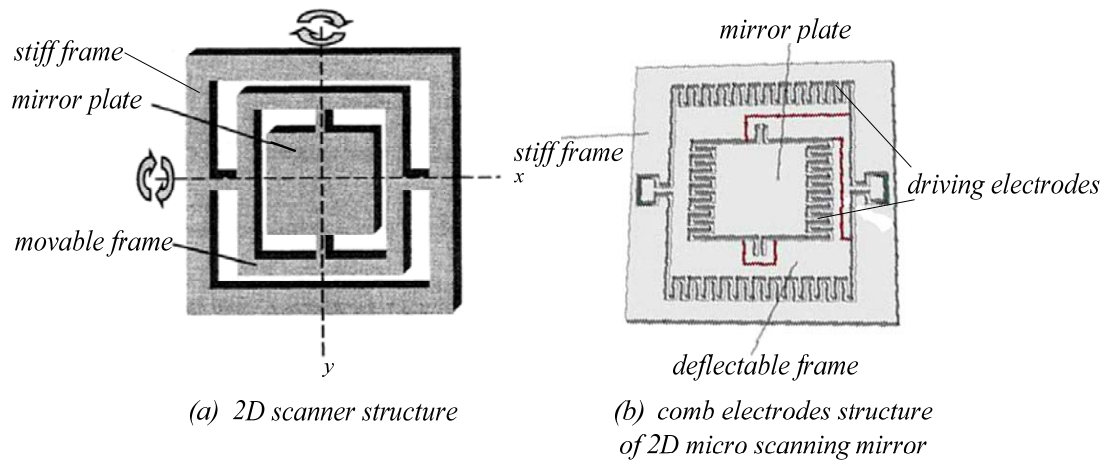

Fig. 6. 2D microscanning mirror with comb electrodes.

#### 4. Results and discussion

The characteristics of the MEMS microscanning lidar prototype are tested. The results show that the dot diameter of laser beam at the MEMS microscanning mirror after collimation is less than 0.5 mm. Due to the mirror surface area is  $2 \times 4$  mm, it is easy to align and collimate the laser beam. The deflection angle is  $15^\circ$  at driving pulse voltage of 25 V, which produces a FOV of  $30^\circ$ . A more larger FOV can be achieved through a use of optical angle amplification, if necessary [2]. The resonant frequency of the mirror is 1.5 kHz which allows a real-time imaging of 15 fps. The range resolution is about 1cm. It can potentially be reduced to a few millimeters, if using advanced edge detection and algorithms.

A MEMS scanning mirror should have three characteristics which are key to lidar system: the maximum deflection angle, the mirror plate area and the resonant frequency. These three characteristics are interdependent, for example, the resonant frequency is inversely proportional to the microscanning mirror area and the square root of the deflection angle. One way to overcome limited mirror area is to use a microscanning mirror array which is composed of several silicon scanning mirrors and each has identical size and parameters [9]. For

instance, using a  $3 \times 3$  scanning mirror array, the total mirror area could be  $72 \text{ mm}^2$ , if each has an identical size of  $2 \times 4 \text{ mm}^2$ . All mirrors are driven with identical frequency, amplitude and synchronous to identical phase. The design of increasing mirror area is able to tolerate the resonant frequency for real-time imaging to generate a  $320 \times 240$  pixels. In addition, the deflection angle can be optically extended [2], therefore it also tolerates the resonant frequency.

#### 5. Summary

A MEMS microscanning lidar is supposed for distance measurement and imaging applications. A collimated laser pulse hit a MEMS scanning mirror via beam splitter, then tilted toward a dot which represents an imaging pixel in the field of view. After the pulse is reflected from the dot of the target, the portion received by the photodetector (PD) via the identical microscanning mirror, the beamsplitter and bandpass filter is then amplified and analyzed. The MEMS micromirror is the key component to effect on performance of the lidar. There are three parameters to represent the performance of the microscanning mirror which are deflection angle, mirror plate area and resonant frequency. To yield signal energy

at the target area, the pulse from a conventional flash ladar would have to be 76800 times more powerful than that from the MEMS single point scanning laser for a 320×240 pixels. Because the reflected pulse is distributed over the entire FPA, the flash ladar will have an additional 76800 times more powerful to yield the identical pulse energy per pixel as the MEMS ladar, resulting in the flash ladar system to become large, heavy, and expensive setup. The new MEMS microscanning mirror ladar with a small size, lightweight, low price, real-time imaging and low power consumption is promising for many applications such as security, robotics, unmanned aircraft and terrestrial vehicles.

### References

- [1] H. Grüger, T. Egloff, M. Scholles, F. Zimmer, H. Schenk, *Laser Focus World*, **44**(7), 52-55 (2008).
- [2] J. P. Seipmann, *Laser Focus World*, [www.laserfocusworld.com/articles/231734](http://www.laserfocusworld.com/articles/231734).
- [3] M. Scholles, A. Bräuer, K. Frommhagen, C. Gerwig, H. Lakner, H. Schenk, M. Schwarzenberg, *Journal of micro/nanolithography, MEMS and MOEMS*, **7**(2), Art. 021001 (2008).
- [4] H. Schenk, T. Sandner, C. Drabe, T. Klose, H. Conrad, *Phys. Status Solidi C*, 2009, 1-8.
- [5] A. Gatto, M. Yang, N. Kaiser, J. U. Schmidt, T. Sandner, H. Schenk, H. Lakner, J. Heber, *Applied Optics*, **45**(7), 1602-1607 (2006).
- [6] S. Hsu, T. Klose, C. Drabe, H. Schenk, *Journal of Optics. A*, No.10, Paper 044005 (2008).
- [7] R. Sprague, et al., *Proc. SPIE 5721*, 1-13 (2005).
- [8] P. Muralt, *IEEE Trans. Ultrason. Ferroelectr. Freq. Contr.*, **47**, 903–915 (2000).
- [9] H. Schenk, U. Dauderstädt, P. Dürr, A. Gehner, A. Wolter, H. Lakner, Springer, Berlin, 89-96, ISBN: 3-540-20252-8 (2004).

---

\*Corresponding author: yikejia2007@163.com