

Constructive aspects and sensor fusion of acoustic and optic proximity sensors in a mini caterpillar robot for patrol and security

V. VADUVA*

Department of Robotics and Data Acquisition, The National Institute for Mechatronics and Measurement Technique-Bucharest, Romania

In this paper there are presented constructive aspects of a novel mini caterpillar autonomous robot for patrol and inspection. This paper first introduces the state of the field in this area, emphasizing the need of a mini sized and compact robot with the characteristics of classical mini-robots combined with the advantages of large size security robots. Furthermore, the paper presents the object detection sensor designing, emphasizing the sensors fusion method using an acoustic (ultrasonic) and an optic (infrared) sensor, starting from their characteristics.

(Received October 22, 2013; accepted November 7, 2013)

Keywords: Autonomous robot, Acoustic sensors, Optic sensors, Fuzzy logic, Caterpillar robot, Mini-robot

1. Introduction

During the last five years, an alternative to traditional security systems was represented by mobile robots. First in Japan, China and SUA and then later in EU countries like Germany and Italy [1], mobile robots began to be used more often for patrol/inspection purposes mostly in closed premises. Depending on the necessary working environment characteristics and requirements, the inspection/patrol robots design began to be personalized: different locomotion methods, different proximal detection sensors and different sensors depending on the desired measurements.

One of the first and also most successful security robots was designed by Civil Aviation University of China and Tianjin YAAN Technology Electronics Co. Ltd [2]. The robot is equipped with 2 differential wheels, it's 90 cm long, 75 cm high, 55 cm wide and weighs 50 kg. The robot can climb slopes up to 15 degrees. It is equipped with a pan-tilt-zoom camera, ultrasonic sensors for avoiding obstacles. This Robot can patrol freely or on a fixed route and sends real-time images to a command center. Later, this version of the robot was upgraded to contain sensors for detecting situations like smoke, noise and temperature

PatrolBot is also an autonomous robot built by MobileRobots Inc. It can come in many configurations depending on the needed application. It can travel at speeds up to 2m/s and carry up to 40 kg over flat surfaces

For obstacles detection it uses ultrasonic sensors and laser rangefinder, also can be equipped with Rear SONAR, Gyroscopic correction systems, speakers, stereo-camera, emergency stop switch, joystick and segmented bumper array. It can map buildings and constantly update its position within 2-3 cm. It can climb slopes up to 12 degrees with a payload of 10 kg. Its autonomous runtime is up to 1-3 hours and recharge via a docking station [3].

Spykee is a security minirobot designed for house. It is manufactured by Meccano and sold under the Erector brand, this robot is a combination remote spy, home security monitor, and mobile VoIP phone. It has motion sensors that will trigger the camera to take a picture and send it to you via e-mail; while sounding an alarm if desired. Its dimensions are 30 × 30 × 30 cm and weighs 2.3 kg. However it doesn't come with large sensor diversity so it can be used only for distance controlled patrol and motion detection [4].

As seen from the suggestive example presented above security and patrol robots are divided into two categories.

Big size security robots that have large sensor capabilities for obstacles detection (laser, ultrasonic, infrared) using sensor fusion algorithms such as Kalman [5] filters method. Also they can be custom equipped for many possible detection scenarios, according to user needs (smoke detection, sound detection, infrared scanning, stereo camera systems, microphone, voice recognition systems etc). They are precise, well-designed and well-equipped but also voluminous, heavy and expensive.

The other category is represented by the classic mini robots for security and patrol. They are small, quick, but they are mainly addressed for distance remote and wireless camera transmission online. Some of them are equipped with sensors for object detection, but just with one kind of sensors (usually an array of ultrasonic detection sensors) thus do not benefit by the advances proximal sensor fusion and also are poorly equipped with scenario detection systems (most of them have just motion detection sensors and microphones).

We proposed to design a mini-robot for inspection and patrol who can have the advantages of the classic mini-robots (small dimensions for fitting in small places, low weight, can climb high slopes, large battery autonomy but also have some of the advantages of big sized robots (two

proximal sensor systems using sensor fusion structures for precise detection, and also auxiliary sensors for many possible detection scenarios in industrial premises)

Our designed mobile robot-MCAR (Mini Caterpillar Autonomous Robot) represented in Fig. 1 was mechanical built in a caterpillar configuration with a double toothed belt and with toothed wheels for better contact with soil and for minimizes the sliding on shiny surfaces. Also, the caterpillar allows the robot to adjust to different inclinations of the soil and avoid getting blocked in situations where wheels robots usually are (pits, small obstacles which can block a wheel).

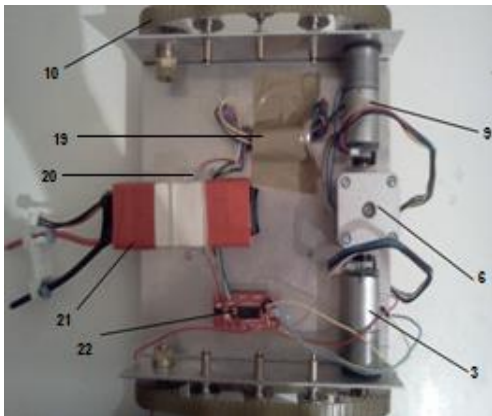
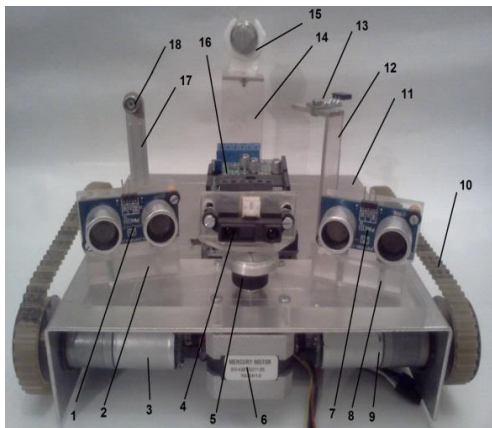

Fig. 1. Front and back view of the MCAR (1-Right ultrasonic sensor, 2-Right ultrasonic sensor support, 3-Right side wheel actuator, 4- Infrared sensor, 5- Infrared mobile platform, 6-Stepper Motor, 7-Left ultrasonic sensor, 8- Left ultrasonic sensor support, 9-Left side wheel actuator, 10-Double toothed belt, 11-Mini-robot case, 12-Light sensor support, 13-Light sensor, 14-Dangerous gas sensor support, 15-Dangerous gas sensor, 16-Electronic command board and actuators driver, 17-Noise sensor support, 18-Noise sensor, 19-Packed wires, 20-Battery Support, 21-Battery, 22-Stepper driver).

In order for the user to define the path where is necessary for MCAR to patrol, it was created an interface where the user can define the patrol key points. The input

data represents the coordinates of key points related to the starting position of the robot. These key points can be followed in a particular order by the robot or in a random order for unpredictability.

MCAR is equipped with sensors for detecting smoke, hazardous gas, noise, and light, for indicating situations like: fire, gas leak, broken pipes, broken window and possible burglary. For each of these sensors the user must define a normal interval suitable for the premises. Any limits exceeding of any of these intervals leads the MCAR to trigger an alarm. The MCAR logical diagram is represented in Fig. 2.

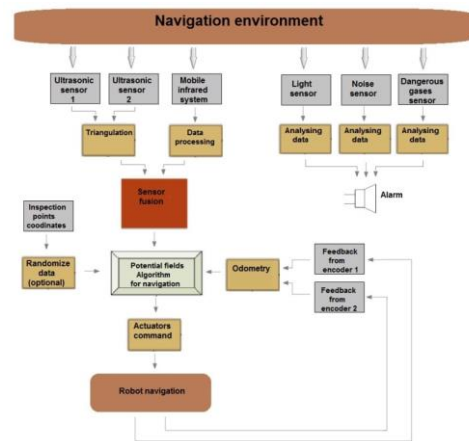

Fig 2. MCAR logical diagram.

The algorithm used for navigation is based on a potential fields version method where the possible obstacles are represented as repulsive fields and key points as an attractive field as in Fig. 3. The vector sums of these components give us the optimal path of the robot.

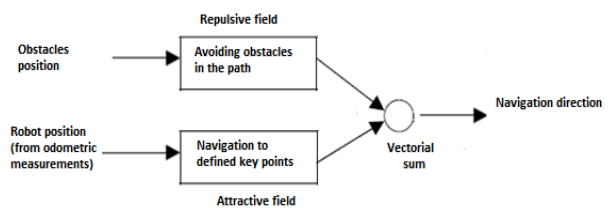

Fig. 3. Classical potential fields diagram adapted to MCAR.

As in most classic potential fields, the smaller the distance to the obstacle, the higher the rejection field has a higher power and as the distance to the target is larger, the attraction field becomes higher

2. Proximal detection systems of the mini-robot

To avoid structures and object situated in robot path, MCAR uses two distinct sensor structures. The first structure is composed by two ultrasonic sensors and the

obtained information is the input data for the geometric triangulation algorithm. The output data of the algorithm are the distance and orientation of the obstacles related to the position of the robot. In Fig. 4 is represented the triangulation algorithm principle

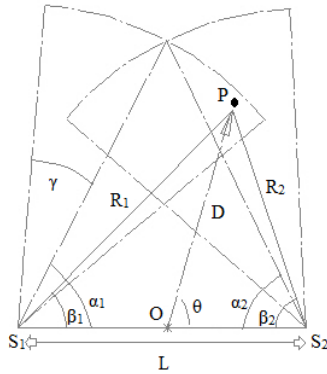

Fig. 4. Geometric principle of triangulation (R_1 is the S_1 sensor detected distance, R_2 is the S_2 sensor detected distance, L is the distance between sensors, β_1 is the angle of sensor 1 towards the detected obstacle, β_2 is the angle of sensor 2 towards the detected obstacle, α_1 is the tilt angle of the sensors 1 towards to horizontal, α_2 is the tilt angle of the sensors 2 towards to horizontal, θ is the angle of the detected object towards the central point O , γ is half of the sensors detection cone angle).

The algorithm equations according to Wijk [6] are:

$$\cos \beta_1 = \frac{L^2 + R_1^2 - R_2^2}{2LR_1} \tag{1}$$

$$D = \sqrt{R_1^2 + \frac{L^2}{4} - R_1L \cos \beta_1} \tag{2}$$

$$\theta = \cos^{-1} \frac{R_1^2 - \frac{L^2}{4} - D^2}{LD} \tag{3}$$

The second sensor structure consist in a infrared sensor with a incremental angular movement of 30^0 right and 30^0 left, mounted in a platform that is controlled by a stepper motor. The infrared sensor is preferable compared to other sensors due to the narrow beam of detection, reaching almost straight line. Also, due to the continuous movement of the platform in which the sensors are mounted we need a quick response from sensors, and the rapid response from infrared sensors (39 ms) [7] makes them perfect for implementation. With this designed mobile platform, we can detected the distance to the obstacle (distance data from infrared sensor) and also the angle in which the obstacle is related to the robot (from the number of steps made by the stepper until the detection)

Although the two sensor system can work individually providing reliable results, it has been developed a special fuzzy sensor fusion structure based on the tested characteristics of the sensors. The main purpose of the

proposed sensor fusion between this two systems is that consulting the technical characteristics of the sensors and by practical precise tests using the precise measurement device F-206.S HexAlign™ 6 Axis-Hexapod for nano-alignment and nano-orientation [8] we determined that each systems has intervals when is more precise and where is less precise, depending on the distance of the robot related to the obstacle and on the angle of the robot related to the obstacle. These data were transposed into fuzzy rules presented in Table 1. There were defined 3 linguistic parameters (small, medium and large) to define the position (distance, angle) of an obstacle. Also the same 3 parameters are used to define to the weight in each case.

Table 1. Fuzzy rules of MCAR infrared proximal detection system.

Input data		Output data	
Distance	Angle	Distance weight (w_{11})	Angle weight (w_{12})
Small	Small	Large	Small
Small	Medium	Large	Medium
Small	Large	Large	Large
Medium	Small	Medium	Small
Medium	Medium	Medium	Medium
Medium	Large	Medium	Large
Large	Small	Small	Small
Large	Medium	Small	Medium
Large	Large	Small	Large

Table 2. Fuzzy rules of MCAR ultrasonic proximal detection system.

Input data		Output data	
Distance	Angle	Distance weight (w_{21})	Angle weight (w_{22})
Small	Small	Small	Large
Small	Medium	Small	Medium
Small	Large	Small	Small
Medium	Small	Medium	Large
Medium	Medium	Medium	Medium
Medium	Large	Medium	Small
Large	Small	Large	Large
Large	Medium	Large	Medium
Large	Large	Large	Small

The designed Fuzzy algorithm presented in Fig. 5 inputs is the sensorial system data (distance to the obstacles, angles of which the obstacles are situated related to the obstacles) and the outputs are the corrected parameters.

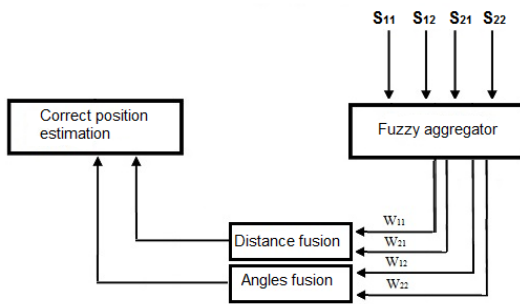

Fig. 5. Fuzzy algorithm structure for the mini-robot sensor fusion system (S_{11} the distance detected by the infrared system, S_{12} is the angle of which the obstacle is positioned related to the robot, detected by the infrared system, S_{21} is distance detected by the triangulation ultrasonic system, S_{22} is angle of which the obstacle is positioned related to the robot, detected by the triangulation ultrasonic system W_{11} is the weight of the distance detected by the infrared system, W_{12} is the weight of the angle of which the obstacle is positioned related to the robot, detected by the infrared system, W_{21} is the weight of the distance detected by the triangulation ultrasonic system, W_{22} is the weight of the angle of which the obstacle is positioned related to the robot, detected by the triangulation ultrasonic system).

Considering f_1 being the function for estimating the measured distance to the obstacle and f_2 being the function for estimating the angle of which the obstacle is positioned related to the robot the equations are:

$$f_1(S_1, S_2) = \frac{S_{11}W_{11} + S_{21}W_{21}}{W_{11} + W_{21}} \quad (4)$$

$$f_2(S_1, S_2) = \frac{S_{12}W_{12} + S_{22}W_{22}}{W_{12} + W_{22}} \quad (5)$$

3. Testing the MCAR system

To validate the usefulness of MCAR, we must demonstrate that the designed system has the performance of the already existing autonomous mini robots used for patrol, but also to keep the sensor detection advantages of the big autonomous robots used for patrol. For that, it was established several performance criteria:

First performance criteria represent the robot capacity to reach the inside of the key points circles (inside of the key point circles represents the interior surface of the circle with the center in the defined key point and the radius of 2 cm).

The second performance criteria represents the time in which the robot travels between two key points. Due to the navigation algorithm which sets the optimum speed depending on the presence and closeness to the obstacles, it is very hard to quantify an optimum time. However, taking into account the navigation speed of the MCAR system when it is not in the presence of obstacles

(0,25m/sec) and considering a coefficient $c_0=0.75$ for the movement in the presence of obstacles we can consider a medium navigation speed of

$$V_m = 0.25 \text{ m/s} * 0.75 = 0.18 \text{ m/s} \quad (6)$$

Therefore the maximum time admitted between two key points will be

$$t = \frac{d}{0.18 \text{ m/s}} \quad (7)$$

where d is the distance between the two key points

The third performance criteria is the ability of the robot to climb slopes up to 30 degrees.

During the movement between the inspection points, MCAR will have to detect and alarm the following situations: luminosity outside of the normal parameters (pre-defined), noise outside of the normal parameters (pre-defined), smoke and hazardous gases with a concentration exceeding the normal one (pre-defined).

The capacity of the MCAR to proper detect these parameters and signal the exceeding of the proper defined interval is the fourth performance criteria.

According to the sensor data sheet, the MQ-2 used in designing the MCAR can detect smoke and hazardous gases starting with 300 ppm, so the maxim limit allowed in atmosphere will be this value.

To establish the critical detection level of the noises, we need to know in the first place, the noise level that the robot is producing. So, the MCAR system was tested with high performance acoustic system [9] and the noise level was established to 43.3 dB. So, we defined the maximum noise limit allowed to 50 dB. In Table 3 are represented several activities that can be performed in the premises and the noise level produced by them

Table 3. Activities that can be performed in a closed room and the noise level produced by them.

Activity	dB	Exceeding the limit
Quiet (threshold of hearing) acoustic laboratory	0	No
The noise of a needle dropped	10	No
Ticking of a clock	20	No
Whispers	30	No
The typical noise of an apartment	40	No
normal conversation	60	Yes
Phone or similar object dropped on the floor (hardwood or tile)	70	Yes
The noise of broken glass	80	Yes
Broken door	115	Yes

The room where the testing took place was illuminated with a 60 W incandescent bulb which produces a light intensity of 710 lm. So the interval

considered normal is (700 -720 lm) and any detection outside this range will be alarmed by the MCAR.

The test was made in the room presented in Fig. 5, in three MCAR proximity sensors configurations:

- Infrared mobile sensor system
- Ultrasonic triangulation system
- Fuzzy sensor fusion of the above system

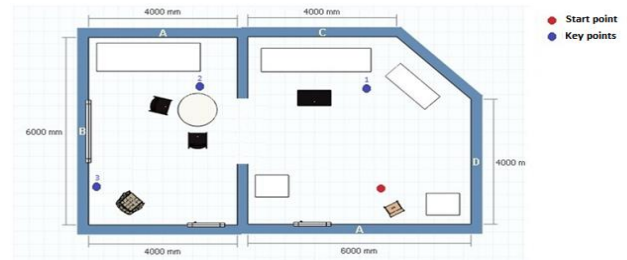

Fig. 5. Testing room.

The configuration of the room and also the testing results are presented on Tables 5 and 6.

Table 5. Testing results on different proximity sensor configurations.

	Key point 1 with coordinates (400, 3200)	Key point 2 with coordinates (4400, 3200)	Key point 3 with coordinates (7200, 0)
Infrared mobile sensor system	MCAR reached the inside of the key points circle, passing right through the center The travel time was 12.8 sec	MCAR reached the inside of the key points circle, passing at a distance of 0.7 cm from the center. The travel time was 51 sec	MCAR reached the inside of the key points circle, passing at a distance of 0.9 cm from the center. The travel time was 29 sec
Ultrasonic triangulation system	MCAR reached the inside of the key points circle, passing right through the center The time was 12.8 sec	MCAR reached the inside of the key points circle, passing at a distance of 0.5 cm from the center. The travel time was 45 sec	MCAR reached the inside of the key points circle, passing at a distance of 0.6 cm from the center. The travel time was 27 sec
Fuzzy sensor fusion of the above systems	MCAR reached the inside of the key points circle, passing right through the center The time was 12.8 sec	MCAR reached the inside of the key points circle, passing right through the center The travel time was 40 sec	MCAR reached the inside of the key points circle, passing right through the center. The travel time was 25 sec

Table 6. Testing results of MCAR detection systems.

Luminosity outside of the establish parameters	Noise outside of the establish parameters	Smoke and hazardous gases outside of the establish parameters	Navigation on slopes
MCAR detects any light intensity out of the established interval and triggers an alarm	MCAR detects any noise beyond the established limit and triggers an alarm	MCAR detects any concentration beyond the established limit and triggers an alarm	MCAR can climb slopes up to 45 degrees

4. Conclusions

The tests performed allowed us to evaluate the MCAR system. The conclusions were:

1. Any change in luminous intensity is detected and signalized promptly
2. MCAR detects and signals any concentration in smoke or hazardous gases above 300 ppm
3. MCAR can successful detect and signal any noise above 50 dB
4. Navigation on slopes up to 45⁰ is done without any blockage or slippage
5. MCAR battery autonomy is at least 12 hours
6. When there are no obstacles on the mini-robot path, the robot positioning towards the key points and also the necessary time for moving between two key points are equal in all tested sensor configurations.

In cases where between two key points are obstacles, the configuration with sensor fusion through fuzzy algorithm provides better results (in positioning and time)

7. The positioning error of the robot related to key points can be cumulative, so running the robot a long time can lead to large cumulative errors. The future improvements of the MCAR will contain alternatives like a differential GPS system or an electromagnetic sensor system for recalibrating the position of the robot

The designed mini-robot can patrol in industrial closed premises while accurate detecting gas leaking, fires, intrusions or even malfunctions of electrical light system due to the light sensors incorporated. It has large battery autonomy and can climb slopes up to 45 degrees.

Also, MCAR proximal sensors for object detection are different from the classic ultrasonic array meet in the most standard patrol robots, the proposed sensor systems model been constructed around the characteristics of ultrasonic and infrared detection system.

MCAR it's an autonomous mini-robot that cumulates the know advantages of mini-robots currently used for patrolling with the features of large autonomous robots for patrol and inspection.

References

- [1] IFR- International Federation of Robotics
[<http://www.ifr.org/industrial-robots/statistics/>].
- [2] Technovelgy website, source:
[<http://www.technovelgy.com/ct/Science-Fiction-News.asp?NewsNum=828>].
- [3] Adept mobile robots website, source:
[<http://www.mobilerobots.com/researchrobots/researchpatrolbot.aspx>].
- [4] Robot rule website, source:
[<http://www.robotrule.com/html/spykee.php#features>].
- [5] Sasiadek, J. Z. Dept. of Mech. & Aerosp. Eng., Carleton Univ., Ottawa, Ont., Canada "Sensor data fusion using Kalman filter", Information Fusion 2000. FUSION 2000. Proceedings of the Third International Conference on (Volume 2), ISSN 2-7257-0000-0, Paris, France, 10-13 July 2000, pp 1-8.
- [6] Chris Gearhart, Alex Herold, Dr. Brian Self, Dr. Charles Birdsong, Dr. Lynne Slivovsky, SAS 2009 – IEEE Sensors Applications Symposium, New Orleans, LA, USA - February 17-19, 2009, pp. 1-3.
- [7] GP2Y0A21YK/Sharp Infrared Sensor Datasheet, pp. 1-5.
- [8] F-206.S HexAlign™ Manual, General Specifications, pp. 1-5.
- [9] Sound level meter 2013 Datasheet, pp 1-2.

*Corresponding author: vladvaduva7@yahoo.com