

Study on performance degradation of organic solar cell based on P3HT–PCBM

HENG MA^{a,b*}, CHUANKUN WANG^{a,b}, YUFENG ZHANG^{a,b}, CHENXI LI^a, GUANGHUA JING^a,
YURONG JIANG^{a,b}

^a Department of Physics, Henan Normal University, Xinxiang, 453007, China

^b Henan Key Laboratory of Photovoltaic Materials, Xinxiang, 453007, China

The current study reports the performance degradation of the short-circuit current density, open-circuit voltage, fill factor, and conversion efficiency of organic solar cells made of poly(3-hexylthiophene) and [6,6]-phenyl C61 butyric acid methyl ester. These parameters, which are functions of time, were measured as functions of durability at low room temperature (below 10 °C). The short-circuit current density and open-circuit voltage were found to decrease along an approximate exponential decay as a function of total time. The fill factor of the cells increased in a zigzag manner. The result of the conversion efficiency showed a rapid index decrease.

(Received December 6, 2011; accepted February 20, 2012)

Keywords: Short-circuit current density, Open-circuit voltage, Fill factor, Conversion efficiency

1. Introduction

Recently, polymer solar cells have attracted extensive interests because of the advantages they offer, such as reusability, light quality, flexibility, eco-friendliness, low cost, and simple and quick production process [1-4]. Moreover, polymer solar cells have more production processes than silicon cells; thus they can reduce the production costs of solar cells via spin coating, ink-jet printing, and roll of volume production [5,6].

However, some problems still restrict the application of organic solar cells (OSCs) in the level of technology today. Low power conversion efficiency (PCE) is an important imperfection. In 1995, the efficiency of the first OSC hetero-junction was less than 1% [7]. In 2003, new materials, namely, poly(3-hexylthiophene) (P3HT) and [6,6]-phenyl C61 butyric acid methyl ester (PCBM), were used on OSCs. Their efficiency reached nearly 3.5% [8]. In 2011, the efficiency of the OSC created by Mitsubishi Chemical reached 8.5%, which is the highest in the world. However, OSCs continue to experience obvious insufficiencies in cell structure and manufacture technology in their commercial applications [9]. The stability and working life of OSCs also face severe problems. For instance, the short-circuit current density of OSCs decreases under continuous illumination in hot dry air, but the open-circuit voltage and fill factor increase in wet dark environments, leading to reversible and irreversible attenuations in the applied performances of OSCs in a practical environment [10-12]. A number of studies on the stability or lifetime of OSCs have recently

been reported. These reports have shown some important methods for reducing the performance attenuation of encapsulated cells [3,12 -14]. However, only a few studies on un-encapsulated cells have been reported. To the best of our knowledge, there are no reports on P3HT and PCBM, especially at low room temperatures (below 10 °C). Therefore, the current study mainly reports the performance attenuation of OSCs made of P3HT and PCMB by measuring their open-circuit voltage, short-circuit current density, fill factor, and PCE.

2. Experiment

2.1 Materials

In the current study, the active layer was made of donor P3HT (Luoyang Light Material technology Co., LTD) and acceptor PCBM (Luminescence Technology Corp.). PEDOT:PSS (Luminescence Technology Corp.) was used as the hole transport layer. Figs. 1 and 2 show the molecular structure and cell structure of the solar cell, respectively.

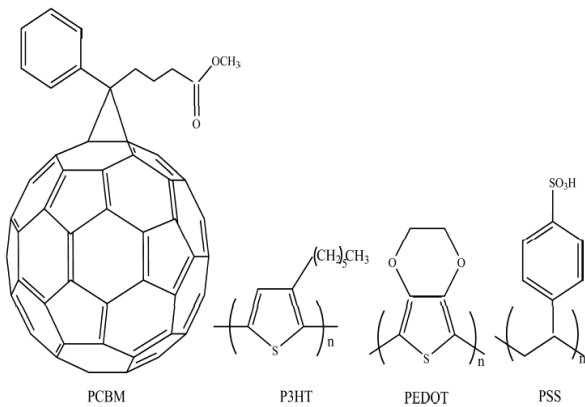

Fig. 1. Molecular structures of PCBM, P3HT and PEDOT:PSS.

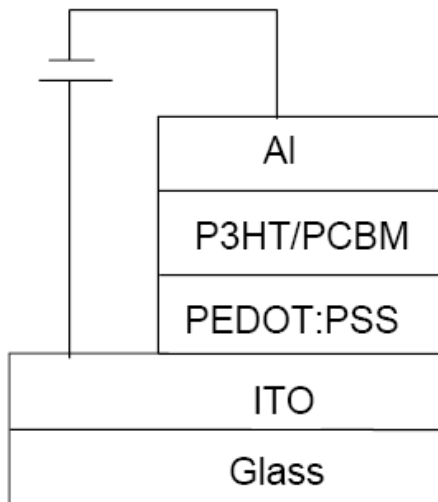

Fig. 2. Structure of the organic solar cells.

2.2. Sample preparation and measurement

Fig. 2 shows the structure of the solar cell used in the current study. The selected ITO substrate had light transmittance of 85% and sheet resistance of $15\Omega/\square$. The glass substrate was cleaned with an ultrasonic cleaner in the sequence of detergent, deionized water, acetone, and alcohol for 15 min. Then, the clean substrate was baked for 20 min and then placed in a glove box. The filtered PEDOT:PSS was spin-coated at 2,500 rpm for 60 s, and then baked at 200°C for 5 min.

The active layer of the OSC was manufactured with a mixture of P3HT:PCBM mixed at a ratio of 1:1. The mixture was dissolved in chloroform with 1 wt% and then stirred for 40 h at 30°C . Then, the active layer over the PEDOT:PSS was spin-coated at 1,400 rpm for 60 s. Finally, an annealed procedure under air atmosphere was implemented on the active layer at 140°C for 5 min.

In the current experiment, the negative electrode of the OSC composed of Al was prepared via magnetron

sputtering deposition method with a thickness of 70 nm at 0.5 pa. The four intact devices with area of 4 mm^2 were manufactured under the same condition for the measurements at the end of the experiment.

The photovoltaic characteristics were measured under AM 1.5 G irradiation at $1,000\text{ W/m}^2$ using Abet Xenon arc lamp in atmosphere (Beijing 7-star Optical Instrument Co., LTD). The four-point probe method was used to measure I-V data with a Keithley 2400A computer control system. All the cells were measured at room temperature below 10°C . The PCE and the fill factor of the cells were calculated as follows [14]:

$$FF = \frac{I_{\max} V_{\max}}{I_{sc} V_{oc}} \quad (1)$$

$$\eta = \frac{FF \times V_{oc} \times I_{sc}}{P_{in}} \quad (2)$$

where, V_{oc} is the open-circuit voltage, I_{sc} is the short-circuit current, P_{in} is the incident light power, I_{\max} and V_{\max} signify the voltage and current at maximum power, respectively.

3. Results and discussion

Unlike conventional inorganic solar cells, OSCs produce excited bound electron-hole pairs, such as excitons, under illumination. These excitons need to be dissociated into free charge carriers with high yield to achieve substantial energy-conversion efficiencies. Excitons can be dissociated at the interfaces of materials with different electron affinities via electric fields. In the current study, the hole transferred from the highest occupied molecular orbital of the donor P3HT to the ITO anode. On the other hand, the electron transferred from the lowest occupied molecular orbital of the acceptor PCBM to the Al cathode. The device then worked as a photovoltaic cell.

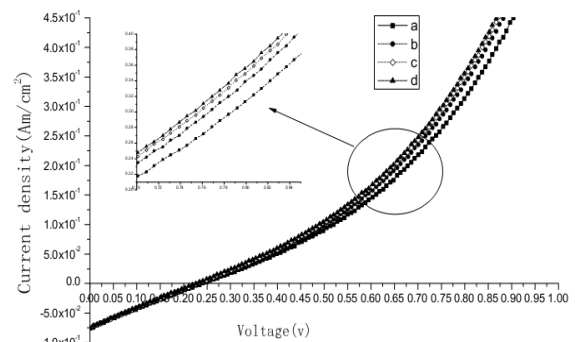

Fig. 3. Voltage and current density curves under the inertia 2 minutes of light illumination.

In the first few times after the OSCs finished, the performance changes of the cell were quick. Fig. 3 shows the shift in the I-V curves of a cell during the first 2 min under continuously simulated illumination. The measuring order within 2 min was a, b, c, and d. As shown in the figure, the I-V curves of the four measurements overlapped. The I-V curves in the initial measurements a and b showed an obvious up shift. With continuous illumination, the curves of c and d began to slightly overlap, indicating that both the short-circuit current density and open-circuit voltage decreased with time. Therefore, the performance attenuation of the nascent OSCs was prominent during the early stage.

The four intact OSCs named A, B, C, and D were manufactured and valued under the same condition as above. The experimental data, including the short-circuit current density, open-circuit voltage, fill factor, and PCE, were collected. The experimental data were used to understand the performance change, as shown in Figs. 5 to 8.

Figs. 4 and 5 show the change in the open-circuit voltage and short-circuit current density, respectively, as a function of increasing shelf time. The purity of P3HT was low; thus the performances of the OSCs in the current study were not perfect. Both the open-circuit voltage and short-circuit current density were comparably smaller than expected. As shown in Fig. 5, the values of the open-circuit voltage of the four OSCs dropped sharply at the outset. The values of the voltage decreased by about 50% within the first 5 hours. Moreover, the attenuation of the voltage flattened after six hours. In the current study, curve-fitting was conducted on the open-circuit voltage with increasing time using an exponential function. The varied relationships between voltage and shelf time were found to show a normative quadratic exponential function.

The values of the short-circuit current density of Cells A and C showed slight and transitory increase at the initial time, and then began to decrease with increasing time. However, just like the open-circuit voltage, the values of the short-circuit current density of Cells B and D dropped directly with increasing time. Using curve-fitting, the short-circuit current density of the cells also showed a normative quadratic exponential function during the decreasing stage. The values of the short-circuit current density of Cells B and C were lower than those of Cells A and D.

The photogeneration current intensity in the circuit was influenced by many factors[15]. In the current study, the film resistance, impurity substance in the P3HT, and film quality of the active layer of the OSCs might have affected the decay of the devices, resulting in their weak current. In addition, the cells were not encapsulated; thus, they were very susceptible to oxygen and moisture in the atmosphere. Therefore, the hole transport ability of the water-soluble PEDOT:PSS became weak. Similar to the suggestion proposed by many researchers, the active organic layer was easily oxidized and hydrolyzed in the atmosphere. Therefore, if the OSCs are not encapsulated,

the short-circuit current density and open-circuit voltage will reduce sharply and till to almost zero.

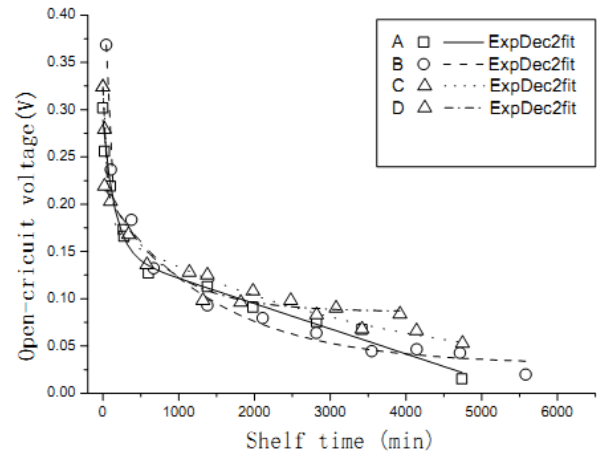

Fig. 4. The open-voltage curves as a function of increasing.

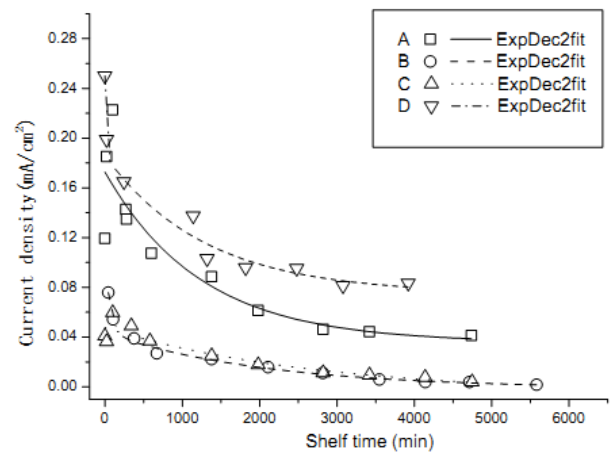

Fig. 5. Short-circuit current density curves as a function of time.

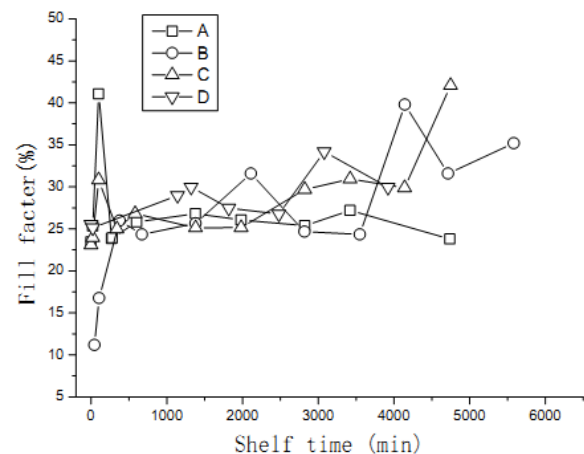

Fig. 6. The fill factor curves as time goes.

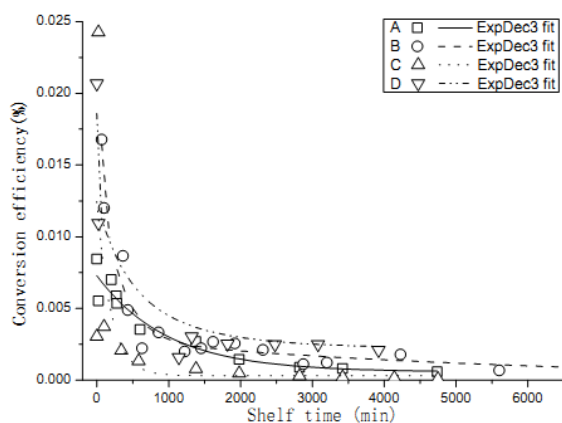

Fig. 7. The conversion efficiency curve as time goes.

Using the measurement data, the fill factors of the devices were derived from Eq. (1). Fig. 7 shows the variations in the curve as a function of increasing time. The fill factors showed lower values compared with the results obtained by some research groups in the literature [12,13]. The lower values were possibly caused by the film defect, which gave rise to the large compound rate of the carriers. Moreover, the un-encapsulated cells significantly increased the series resistances. As a whole, the curves of the fill factors expressed a zigzag increase with increasing shelf time, whereas the interval of light illumination was not continuous. These results indicate that the fill factor of OSCs might have a reversible effect. In other words, the fill factor has a fatigued restoring function under the illumination condition of work in snatches.

Fig. 7 shows the variations in PCE with increasing shelf time. The PCE dropped quickly in the first six hours, and then the curves flattened. Similar to the curves of the short-circuit current density, some PCEs of the devices, such as A and C, can be attenuated to zero. As shown in Figs. 4 and 5, both the short-circuit current density and open-circuit voltage showed normative quadratic exponential decay as a function of the length of shelf time. In the current study, curve-fitting was conducted on the PCE and shelf time. The PCEs showed normative cubic exponential decay as a function of time length, and not a quadratic function, indicating that the zigzag fill factor also contributed to the PCEs. The most serious causes of bad fill factor and PCE in the current study were probably the film defect and high resistance caused by the materials and manufacturing processes [16]. However, the current research was an estimate study on the performance attenuation of OSCs, so the differences among the variation curves were obvious.

4. Conclusion

The attenuation properties of the open-circuit voltage, short-circuit current density, fill factor, and PCE were

discussed. The open-circuit voltage, short-circuit current density, and PCE decreased with increasing shelf time, and the decay curves showed normative quadratic and cubic exponential decay functions. Interestingly, the fill factors showed a zigzag curve with increasing time. The experiment showed that the performances of un-encapsulated OSCs decay quickly. Therefore, encapsulation and a more compact metal film for use as top electrode are indispensable for improving the stability of OSCs.

Acknowledgment

This work is supported by the National Natural Science Foundation of China under Grant No. 11074066.

References

- [1] M. K. Siddiki, J. Li, D. Galipeau, Q. Qiao, *Energy Environ. Sci.*, **3**, 867 (2010).
- [2] R. Betancur, M. Maymó, X. Elias, L. T. Vuong, J. Martorell, *Sol. Energy Mater. Sol. Cells*, **95**, 735 (2011).
- [3] J. U. Lee, Y. Do Kim, J. W. Jo, J.P. Kim, W. H. Jo, *J. Mater. Chem.*, **21**, 17209 (2011).
- [4] C. L. Uhrich, G. Schwartz, B. Maennig, W. M. Gnehr, *J. Clin. Inves.*, **120**, 2345 (2010).
- [5] F. C. Krebs, K. Norrman, *Appl. Mater. Interfaces*, **2**, 877 (2010).
- [6] G. Grancini, D. Polli, D. Fazzi, J. Cabanillas-Gonzalez, G. Cerullo, G. Lanzani, *J. Phys. Chem. Lett.*, **2**, 1099 (2011).
- [7] T. Ameri, G. Dennler, C. Lungenschmied, C. J. Brabec, *Energy Environ. Sci.*, **2**, 347 (2009).
- [8] J. Peet, M. L. Senatore, A. J. Heeger, G. C. Bazan, *Adv. Mater.*, **21**, 1521 (2009).
- [9] Y. F. Gao, B. Zhang, W. Liu, Y. M. Ai, *Rock and Soil Mech.*, **30**, 1237 (2009).
- [10] J. A. Hauch, P. Schilinsky, S. A. Choulis, R. Childers, M. Biele, C. J. Brabec, *Sol. Energy Mater. Sol. Cells*, **92**, 727 (2008).
- [11] S. W. Seemann, J. Li, W. P. Menzel, L. E. Gumley, *J. Appl. Meteor.*, **42**, 1072 (2003).
- [12] T. Kawano, S. Kidoaki, *Biomaterials*, **32**, 2725 (2011).
- [13] H. Kim, M. Shin, J. Park, Y. Kim, *ChemSusChem*, **3**, 476 (2010).
- [14] T. Soga, *Nanostruct. Mater. Sol. Energy Convers.*, Science Press, Tokyo, 27-28 (2006).
- [15] L. Chen, Y. S. Qian, X. L. Chen, R. Yang, S. Q. Zhang, *Optoelectron. Adv. Mater. -Rapid Commun.*, **5**, 12 (2011).
- [16] F. C. Wang, H. X. Li, P. Chang, *Optoelectron. Adv. Mater. -Rapid Commun.*, **5**, 6 (2011).

*Corresponding author: hengma@henannu.edu.cn